

SMB SERIES

Double Section Wall Mounted Cabinet

Safewell SMB series double section is really suitable for server rooms, audio rooms, wiring closets, manufacturing areas, warehouses, or anywhere where heavy networking equipment needs to be protected and maintained usually. Slots in back ensure convenient and quick wall mounting.



HORIZON

■ Highlights

Double Section Structure

Swing frame allows the cabinet to swing away from the wall for easy access to equipments and cabling.

Optional Doors

Toughened glass or vented door is optional which is at your choice.

Sturdy Welded Construction

Fully welded and assembled.

Loading Capacity

The loading capacity is up to 60KG.

Big Door-Opening Angle

Turning angle of front door is over 180 degrees; rear door is over 90 degrees.

■ Features



■ Welded structure can be easy assembled.



■ Slots in back ensure convenient and quick wall mounting.



■ 120mm*120mm fans can be preinstalled on the top cover. Relevant fan tray suit to all safewell wall mounted cabinets. (Brush panel is optional for cable entry panel.)



■ Swing frame allows the cabinet to swing away from the wall for easy access to equipment and cabling.



■ Removable side panels simplify your installation of accessories and monitoring of IT equipment.



■ L-shaped spring pin make it fast to install front door to the frame and easy to change door opening direction.

Components of SMB Series Double Section Wall Mounted Cabinet

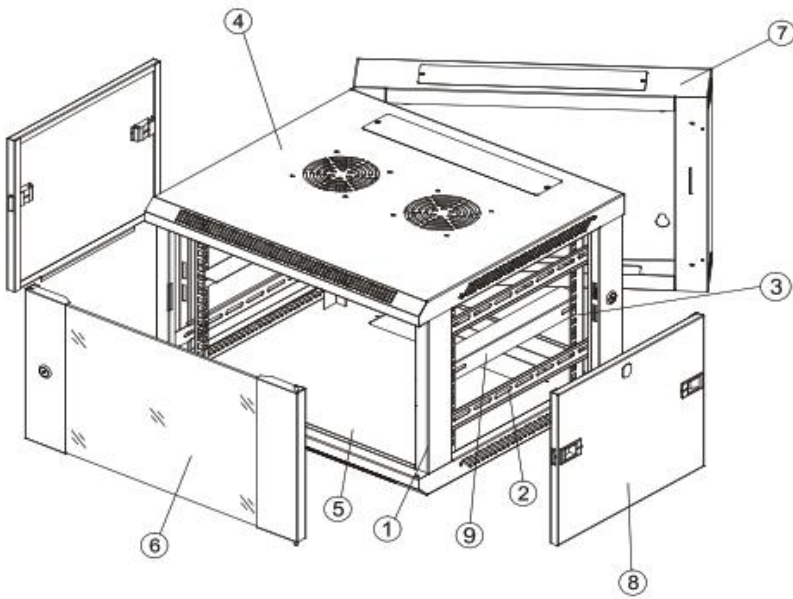

S/N	Name	Quantity
1	Frame	1
2	Horizontal bracket	4
3	Vertical rail	4
4	Top cover	1
5	Bottom panel	1
6	Front door	1
7	Rear swing frame	1
8	Side panel	2
9	L-shaped bracket	2

■ Main Dimension

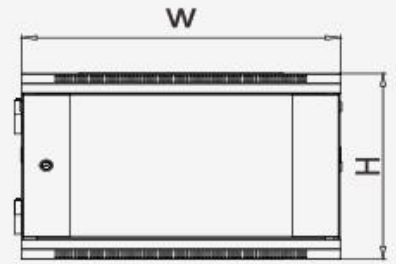

Front View

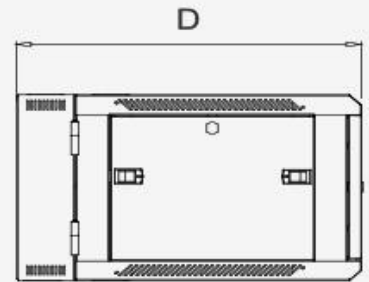

Left View

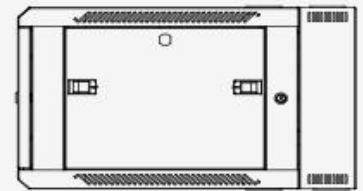

Right View

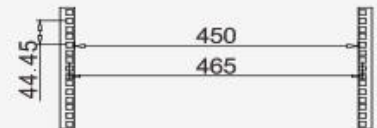

Mounting Dimension



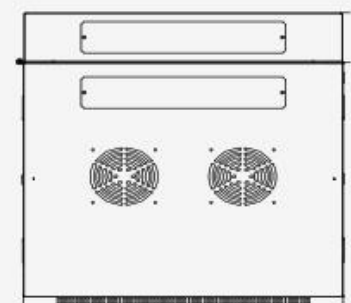

Rear View



Top View

■ Specifications

Model	Capacity (U)	Dimension W*D*H(mm)	BU Packing Dimension	
			W*D*H(mm)	Volume (CBM)
SMB6506	6	600*550*370	615*565*385	0.134
SMB6606	6	600*600*370	615*615*385	0.146
SMB6509	9	600*550*500	615*565*515	0.179
SMB6609	9	600*600*500	615*615*515	0.195
SMB6512	12	600*550*635	615*565*650	0.226
SMB6612	12	600*600*635	615*615*650	0.246
SMB6515	15	600*550*770	615*565*785	0.273
SMB6615	15	600*600*770	615*615*785	0.297
SMB6518	18	600*550*900	615*565*915	0.318
SMB6618	18	600*600*900	615*615*915	0.346

Note	Hardwares: ≤12U: 12 sets cage nuts; >12U: 24 sets cage nuts.	
	Package: Build-up(BU) or Knock-down (KD).	The swing frame is optional, with depth of 100mm.
Color	RAL9005 	RAL7035 
Material	SPCC Cold Rolled Steel.	

■ Optional Doors-Structure Drawing

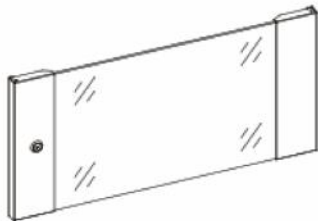

A. Tempered Glass Door
Lock: Small Round Lock

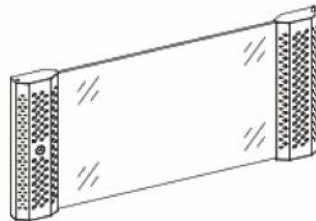

B. Tempered Glass Door, with Vented Holes
Lock: Small Round Lock

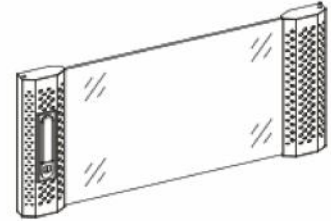

C. Tempered Glass Door, with Vented Holes
Lock: Spring Lock

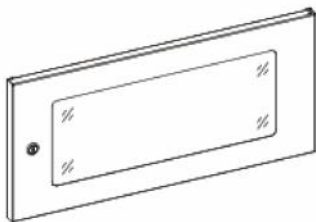

D. Tempered Glass Door
Lock: Small Round Lock

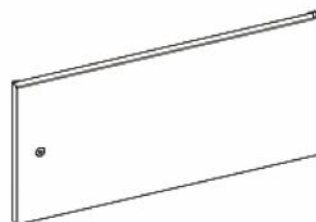

E. Solid Iron Door
Lock: Small Round Lock

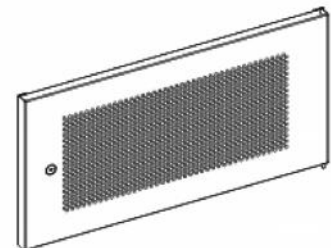

F. Vented Front Door
Lock: Small Round Lock

Note: Other regular 19 inch accessories which is used to all racks (shelf, cable manager, fans, blank panel, patch panel and PDU), please refer to **page 99** to **page 112**.